

**INSTRUCTION MANUAL
ROTATING LASER**

RL-100 1S

FCC WARNING

Changes or modifications not expressly approved by the manufacturer for compliance could void the user's authority to operate the equipment.

In order to comply with FCC radio-frequency radiation exposure guidelines for an uncontrolled exposure, this device and its antenna must not be co-located or operating in conjunction with any other antenna or transmitter.

The term "IC:" before the radio certification number only signifies that Industry Canada technical specifications were met.

"Operation of this device is subject to the following two conditions: (1) this device may not cause interference, and (2) this device must accept any interference, including interference that may cause undesired operation of the device."

"The installer of this radio equipment must ensure that the antenna is located or pointed such that it does not emit RF field in excess of Health Canada limits for the general population; consult Safety Code 6, obtainable from Health Canada's website www.hc-sc.gc.ca/rpb".

Declaration of Conformity

Model Number:	RL-100 1S
Trade Name:	TOPCON CORPORATION
Responsible party:	TOPCON POSITIONING SYSTEMS, Inc.
Address:	7400 National Drive, Livermore, CA 94550, U.S.A.
Telephone number:	925-245-8300

This device complies with Part 15 of the FCC Rules. Operation is subject to the following two conditions: (1) This device may not cause harmful interference, and (2) this device must accept any interference received, including interference that may cause undesired operation.

Foreword

Thank you for purchasing the Topcon RL-100 1S Rotating Laser.

It is one of the world's most advanced and accurate grade-setting lasers. To quickly and effectively use the RL-100 1S, please read these brief instructions carefully, and keep them in a convenient location for future reference.

Handling Precautions

Guarding the instrument against shock

When transporting the instrument, provide some protection to minimize risk of shock. Heavy shocks may affect beam accuracy.

Sudden changes of temperature

A sudden change in temperature may cause water condensation on the glass used for the laser emission part.

In such a case, let the instrument stand for a while to allow it to adjust to the temperature prior to actual use.



Caution:

Use of adjustment controls or performance procedures other than those specified herein may result in hazardous radiation exposure.

Safety Information

In order to encourage the safe use of products and prevent any danger to the operator and others or damage to properties, important warnings are put on the products and inserted in the instruction manuals.

We suggest that everyone understand the meaning of the following displays and icons before reading the “Safety Cautions” and text.

Display	Meaning
 WARNING	Ignoring or disregard of this display may lead to death or serious injury.
 CAUTION	Ignoring or disregard of this display may lead to personal injury or physical damage to the instrument.

- Injury refers to hurt, burn, electric shock, etc.
- Physical damage refers to extensive damage to buildings or equipment and furniture.

The user of this product is expected to follow all operating instructions and make periodic checks of the product's performance. The manufacturer or its representatives assume no responsibility for results of the use of this product including any direct, indirect, consequential damage, and loss of profits.

Safety Cautions

WARNING

There is a risk of fire, electric shock or physical harm if you attempt to disassemble or repair the instrument yourself.

This is only to be carried out by TOPCON or an authorized dealer, only!

Laser beams can be dangerous, and can cause eye injury if used incorrectly .

Never attempt to repair the instrument yourself.

Laser beams can be dangerous. They can cause eye injury.

Do not stare into beam or view directly with optical instruments.

High temperature may cause fire.

Do not cover the charger while it is charging.

Risk of fire or electric shock.

Do not use damaged power cable, plug and socket.

Risk of fire or electric shock.

Do not use a wet battery or charger.

Cause eye injury or blindness.

Do not look at the sun through a telescope.

May ignite explosively.

Never use an instrument near flammable gas, liquid matter, and do not use in a coal mine.

Battery can cause explosion or injury.

Do not dispose in fire or heat.

Risk of fire or electric shock.

Do not use any power voltage except the one given on manufacturers instructions.

Battery can cause outbreak of fire.

Do not use any other type of charger other than the one specified.

The short circuit of a battery can cause a fire.

Do not short circuit battery when storing it.

 **CAUTION**

Use of controls or adjustment or performance of procedures other than those specified herein may result in hazardous radiation exposure.

Do not connect or disconnect equipment with wet hands, you are at risk of electric shocks if you do!

Risk of injury by overturn the carrying case.

Do not stand or sit on the carrying cases.

Please note that the tips of tripod can be hazardous, be aware of this when setting up or carrying the tripod.

Risk of injury by falling down the instrument or case.

Do not use a carrying case with a damaged which belts, grips or latches.

Do not allow skin or clothing to come into contact with acid from the batteries, if this does occur then wash off with copious amounts of water and seek medical advice.

It could be dangerous if the instrument falls over, please check that you fix the instrument to the tripod correctly.

Risk of injury by falling down a tripod and an instrument.

Always check that the screws of tripod are tightened.

Let the laser beam reach the aimed object or the target without anybody else in the laser beam path. When operating in an open area, avoid radiating laser beam at eye level. It is quite possible for the beam to enter into one's eyes, and it is possible to lose visual sight temporarily, and lose one's caution and awareness of other dangers - avoid glaring beam.

Please note that the tips of tripod can be hazardous, be aware of this when setting up or carrying the tripod.

Risk of injury by overturn the carrying case.

Do not stand or sit on the carrying cases.

EXCEPTIONS FROM RESPONSIBILITY

- 1) The user of this product is expected to follow all operating instructions and make periodic checks of the product's performance.
- 2) The manufacturer, or its representatives, assumes no responsibility for results of a faulty or intentional usage or misuse including any direct, indirect, consequential damage, and loss of profits.
- 3) The manufacturer, or its representatives, assumes no responsibility for consequential damage, and loss of profits by any disaster, (an earthquake, storms, floods etc.).
A fire, accident, or an act of a third party and/or a usage any other usual conditions.
- 4) The manufacturer, or its representatives, assumes no responsibility for any damage, and loss of profits due to a change of data, loss of data, an interruption of business etc., caused by using the product or an unusable product.
- 5) The manufacturer, or its representatives, assumes no responsibility for any damage, and loss of profits caused by usage except for explained in the user manual.
- 6) The manufacturer, or its representatives, assumes no responsibility for damage caused by wrong movement, or action due to connecting with other products.

WARNING : Handling the cord on this product or cords associated with accessories sold with this product, will expose you to lead, a chemical known to the State of California to cause birth defects or other reproductive harm. ***Wash hands after handling.***

Laser Safety

Safety Information

This laser complies with all applicable portions of title 21 of the Code of Federal Regulations, Dept. of Health, Education, and Welfare: Food and Drug Administration: Center for Devices: Bureau of Radiological Health.

Do not stare into the laser beam or view directly with optical instruments.

Do not disassemble the instrument or attempt to perform any internal servicing.

Repair and servicing of this laser are to be performed by TOPCON or its authorized dealer.

Caution : Use of adjustment controls or performance procedures other than those specified herein may result in hazardous radiation exposure.

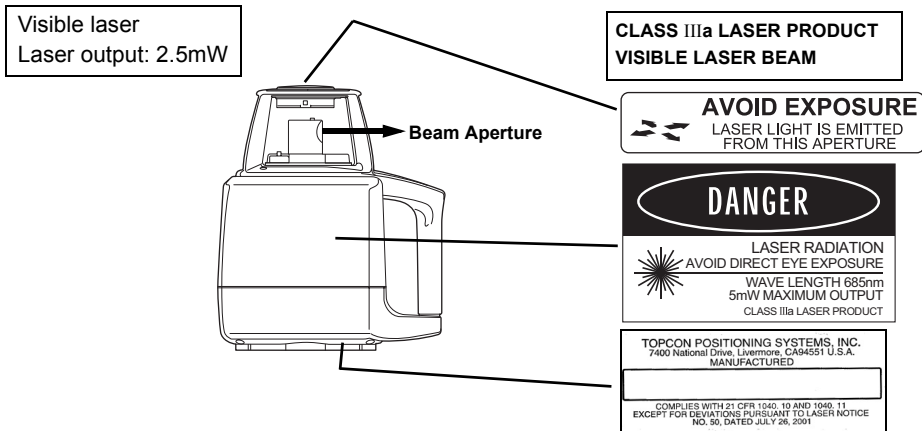

Contents

Foreword	1
Handling Precautions	1
Safety Information	2
Safety Cautions	3
Laser Safety	6
Contents	7
Standard System Components	9
Nomenclature	10
Sample Display	12
Key Functions	13
RL-100 1S LED Display	13
Basic Operation	14
Preparation and Functions	15
Power Source	15
Setting Up Instrument	15
Battery Status Display	16
Setting Grade	17
Aligning Direction of Grade	18
How to Enter Grade	19
Menu	20
How to Set the Menu	20
Switching Masking Mode	22
Maintaining Power Sources	28
How to Change Batteries on the Instrument	28

Check and Adjusting	29
Horizontal Calibration	29
Horizontal Rotation Cone Error.....	33
Grade Setting Error.....	34
Storage Precautions.....	36
Standard/Optional Accessories.....	40
Specifications	45
Error Display	47
FCC WARNING	49
IC WARNING	50

Standard System Components

- 1) Instrument 1pc.
- 2) Level sensor LS-80B 1pc.
- 3) Level sensor holder model 6 1pc.
- 4) Carrying case 1pc.
- 5) D size Manganese battery 4pcs.
- 6) AA Manganese battery (To confirm operation)* 2pcs.
- 7) Instruction manual 1vol.
- 8) Battery holder DB-67 1pc.

- Please make sure that all of above items are in the box when you unpack.

* Batteries included in the package are to confirm the initial operation.

Please replace the batteries provided with new batteries as soon as possible.

Nomenclature

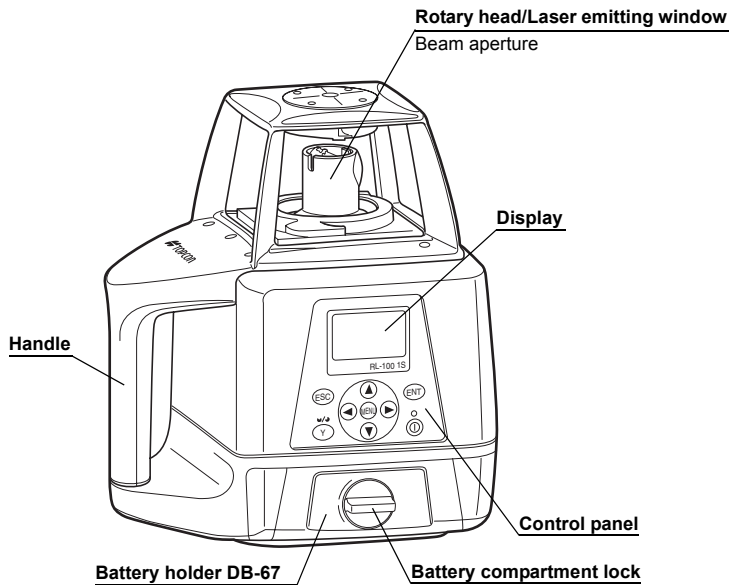

Control panel

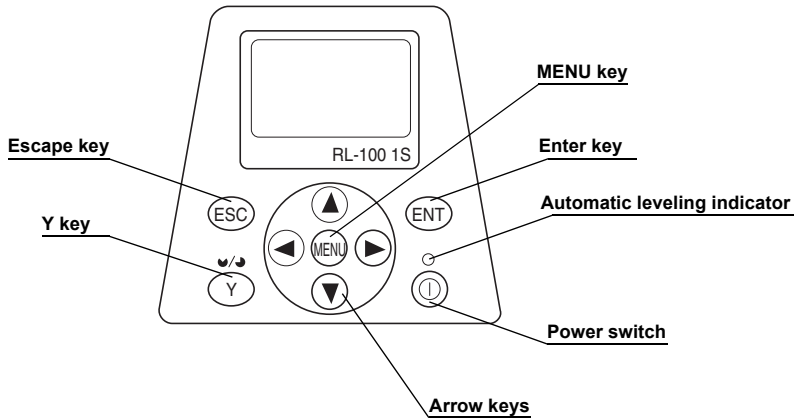

Sample Display

Normal display

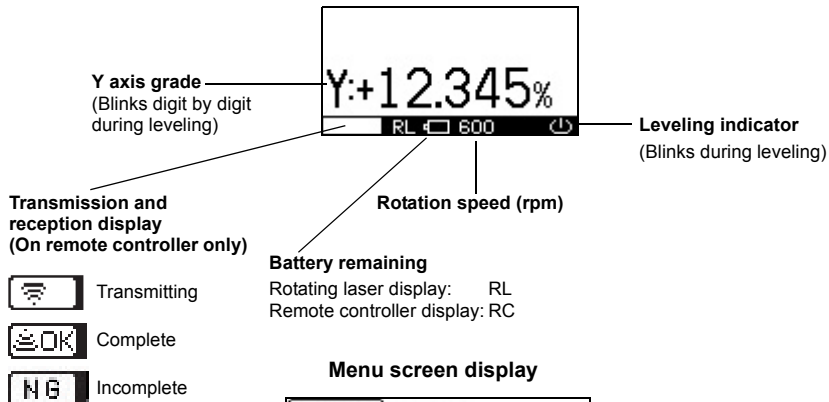





Menu screen display

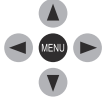

See "Menu" on page 20.

Key Functions

	Enter key	End Operation of Data Input and Sends data to the instrument.
	Escape key	Cancels input or escape to previous status.
	Y key	Sets Y axis grade.
	Menu and arrow keys	Selects menu items. Inputs the grade of Y axis. Sets the masking direction.
	Power switch	On/Off of the RL-100 1S.

RL-100 1S LED Display

There is an LED that signals automatic alignment of the control panel screen of the main instrument.

Flashing : Auto-leveling or grade setting is in process.

The rotary head is not rotating.

ON solid : Auto-leveling grade setting is complete.

The rotary head is active and emits the laser beam.



You can stop the auto-levelling function. Refer to “Menu” on page 20 to stop the function.

Basic Operation

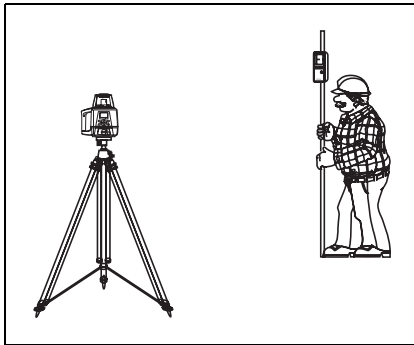

- 1** Set the instrument on a tripod or smooth surface and turn on the power.

When using the remote controller, turn on the power for the instrument, and then the power for the remote controller.

- 2** Set Y axis grade.
- 3** Turn on the level sensor. Check the operation surface by using the level sensor. If high-precision detection is desired, select that setting on the level sensor.
- 4** Check the rotating beam elevation using the level sensor.

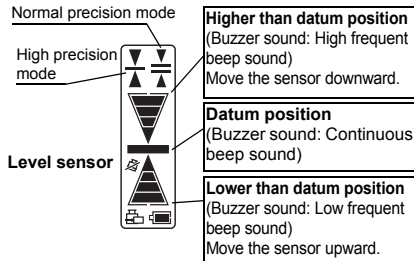

(For more information about level sensor refer to “Standard/Optional Accessories” section.)

Preparation and Functions

Power Source

Connect the battery according to the battery type purchased.

For charging and battery replacement instructions, see the “Maintaining Power sources” section.

Setting Up Instrument

Set the instrument on a tripod or smooth surface.

The instrument must be within horizontal ± 5 degrees of true level for auto-leveling to operate.

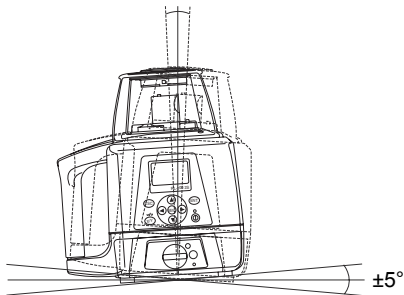

Battery Status Display

Remaining battery level is displayed at the lower bar in the display area.



Battery remaining display

Rotating laser display: RL
Remote controller display: RC



Battery is sufficient.



Battery is sufficient.



Battery is sufficient.



The power is low, but laser is still usable. (Indication continues until batteries are dead.)

RL-100 BATTERY Low Dead batteries of RL-100 1S. Recharge the battery or replace the dry batteries with new ones.



If an AC/DC converter is connected to the main instrument when the main instrument is displaying “RL-100 BATTERY LOW”, the remaining battery level display will not change. Once the power is turned off, the battery remaining display will reset.

For handling batteries, see the “Maintaining Power Sources” on page 28.

Setting Grade

Grade can be set in Y axis, as shown below.

Grade can be set in the range indicated below.

Y: -5% to +25%

Grade axes and axis symbols are as shown in the diagram below.

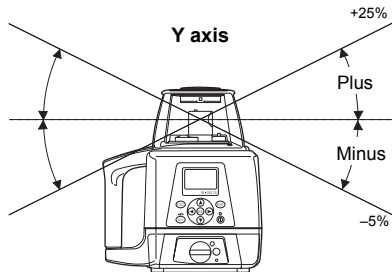

Aligning Direction of Grade

When using the laser with a percent of grade entered, the laser must be properly aligned so the slope of the laser beam is parallel to the desired direction of grade.

The sighting collimator on top of the instrument is calibrated to the grade axis of the laser beam. Follow the steps below to align the laser to the desired direction of grade:

- 1** Establish a target line parallel to desired direction of grade.
- 2** Set up the laser over this line (drop a plumb bob from the tripod mounting screw).
- 3** Rough align the instrument to the direction of grade. Make sure it is properly oriented for the grade to be entered, positive or negative. (See page 17)
- 4** Place a rod or other target down range on the target line.
- 5** While sighting through the collimator, adjust the instrument until the sight is aligned with the target. (See the figures on the right.)

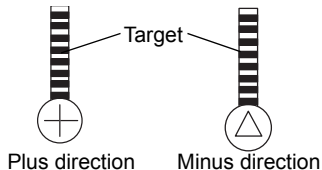
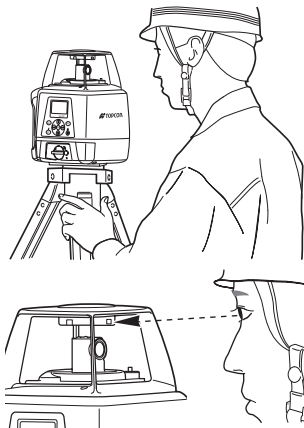
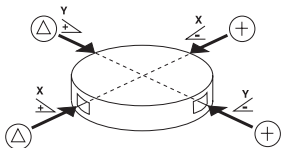

Single axis

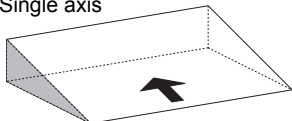

Grade range:
Y: -5% to +25%

How to Enter Grade

- 1** Press the Y key to begin grade input.
The axis symbol will flash and it will go into grade entry status.
- 2** Select positive or negative grade by pressing arrow keys (Up or Down).
- 3** Move the cursor by pressing the arrow keys (Right or Left).
- 4** Increase or decrease the number by pressing the arrow keys (Up or Down).
- 5** Press the [ENT] key to finish input.

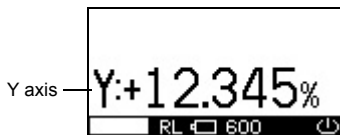

When setting up using the remote controller

Confirm the [OK].

If the [NG] mark is displayed, press the [ENT] key.



When holding down the [Y] key while the Y symbol is flashing, the flashing axis will reset to 00.000%.

Menu

How to Set the Menu

As indicated by arrows in the figure, there are 6 setting categories in the menu and selection and changes of the settings are performed using the arrow keys and [ENT] key.

- 1** Press the menu key to display the menu screen. As you can see, the mask setting is framed with the cursor.
- 2** Move the cursor to the item you would like to set up using the arrow keys and press the [ENT] key. The selected item will start flashing.
- 3** Select the setting details using the arrow keys.
- 4** Press the [ENT] key to lock the setting.
When setting up using the remote controller, make sure that “OK” is displayed on the transmission and reception display. If “NG” is displayed, press the [ENT] key once again.
- 5** In the same manner, select and change the next setting.

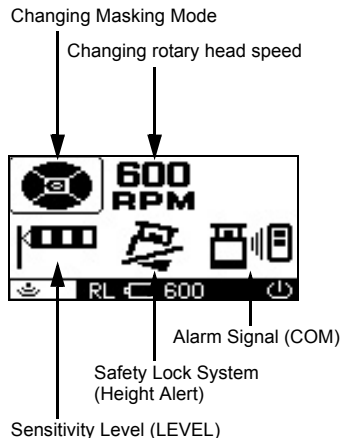

The menu allows setting of the following functions.

- | |
|---|
| 1) Changing Masking Mode 2) Changing rotary head speed
3) Sensitivity Level (LEVEL) 4) Safety Lock System (Height Alert)
5) Alarm Signal (COM) |
|---|

1) Changing Masking Mode

Sets up masking (laser beam shut off) and change shut off directions.

Masking (Laser beam shutter) setting

Depending on the status of the location where the instruments are used, laser beam emission to unnecessary direction can be shut off.

- 1 Press menu key to display the menu screen.
The mask setting will be displayed on the right in the upper side of the screen.
- 2 Use the arrow keys to position on the Mask display and press the [ENT] key.
- 3 Select the direction you desire to mask using the arrow keys.
Each press repeats mask activating/releasing.
- 4 When desired masking is displayed, press the [ENT] key to finish.
Confirm the [OK] mark on the display.



The state when masking is not activated
(Laser beams are emitted to all directions.)

When setting up using the remote controller

After completing 1 through 4 of the above setting procedures, check that the transmission and reception display is showing "OK". If the [NG] mark is displayed, press [ENT] again. ("OK" and "NG" will be displayed only on the remote controller screen.)

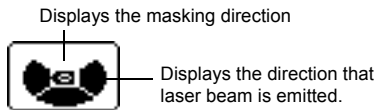

The status in which the X+ direction is masked.
(Laser beam is shut off in the X+ direction.)

Switching Masking Mode

Mode 1

As seen from above

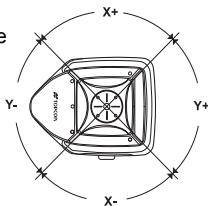

Mode 2

As seen from above

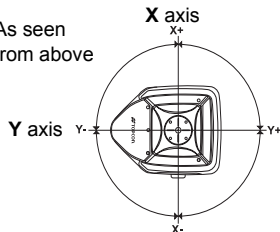

You can select either Mode 1 or Mode 2 for the masking mode (split-masking direction). The relationship between the arrow keys and masking directions are shown in the above figure.

Masking Mode Setting

- 1 Follow steps 1-2 for the masking setting.
- 2 Each press of [Y] key toggles Mask Mode 1 and Mask Mode 2.
- 3 Press the [ENT] key to lock the entry. When setting up with the remote controller, make sure that "OK" is displayed on the transmission and reception display. If "NG" is displayed, press the [ENT] key once again.

Sample display



Mode 1



Mode 2

2) How to change the rotary head speed (300, 600, 900 R.P.M.)

The rotary head speed can be set to 300, 600 or 900 R.P.M.

Press the menu key to display the menu screen. Use the arrow keys to select the rotary head speed and press the [ENT] key. When the head speed starts flashing, select the desired speed using the arrow keys and press the [ENT] key.



Rotation speed

3) Sensitivity Level (LEVEL)

The sensitivity level allows the user to select the vibration level that is permitted during automatic alignment or grade setting. Set a sensitivity level to suit the location where the instrument is used such as places that undergo many vibrations, and also in consideration of the operational precision.

Two sensitivity levels can be set: large and small vibrations.

Manual setting will stop the automatic alignment function.

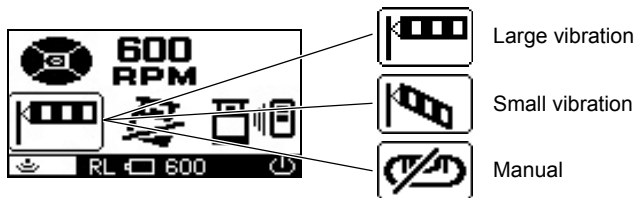

Do not use the manual setting for sensitivity level except in special circumstances. If the manual setting is selected, the automatic alignment function will not operate, so the grading setting precision will not be assured at all. The manual setting will also deactivate the setting for Y-grade.

4) Safety Lock System (Height Alert)

In case the [ALERT] setting is ON. Safety Lock System will active. (This will be active around 10 minutes after turning on the power.)

Should the installed status of the instrument suddenly change when automatic alignment is functioning and laser beam is being emitted, through, for example, unnecessary contact by the user, the automatic alignment function will automatically stop to protect operational precision.

In such a case, the rotary head will act as below:

When [6] Warning transmission] is activated: it will rotate slowly

When [6] Warning transmission] in not activated: the rotation will stop

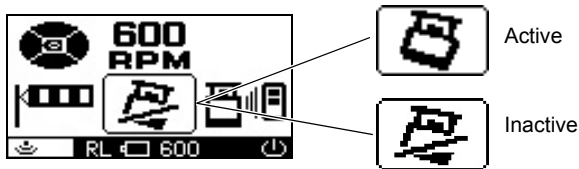

Error : Blinks alternately

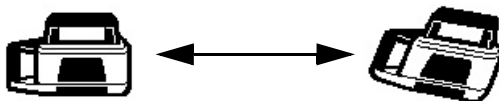

How to reactivate

Turning off the power for the instrument, and then turning it back on will activate the automatic alignment function.

5) Alarm Signal (COM)

When used with the Topcon laser sensor, the RL-100 1S can communicate alarm signals directly to the sensor. This helps enable the user to be completely aware of potential problems before they can become serious.

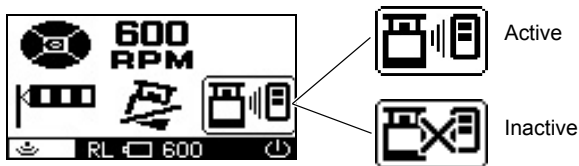

Concerning initial operation in a low temperature

When the instrument and remote controller is used in a temperature below -10°C , a warm up operation of approximately 4 minutes is necessary for the LCD after the power is turned on. During the warm up operation, no operation is possible except turning the power switch on/off. The instrument will perform automatic alignment; however, when the automatic alignment has been completed, the instrument will go into a standby state until the warm up operation is completed (the rotary head is in a resting state). After the warm up operation is completed, the instrument and remote controller will function normally.



During the warm up operation, the instrument will continue the operation even if the power of the remote controller is turned off. (The instrument will not go into a standby state.)

When the power is turned off after the warm up operation is completed, the instrument will begin warm up operation again when the power is back on.

Maintaining Power Sources

How to Change Batteries on the Instrument

Dry battery

How to replace dry batteries

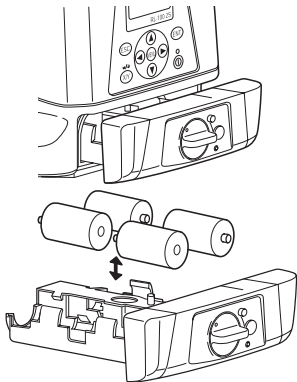

- 1** Remove the battery cover by turning the battery cover knob to “OPEN”.
- 2** Remove the old batteries and replace with new batteries (four D batteries) matching [+] and [-] as shown in the figure.
- 3** Replace the battery cover and turn the knob to “LOCK”.



Replace all 4 batteries with new ones.
Do not mix old batteries and new ones.

Check and Adjusting

Horizontal Calibration

(1) Checking Calibration

- 1 Steadily set up a tripod approximately 50m from a staff member or wall and adjust so that the head of the tripod is horizontal.
Mount the instrument on the tripod in the direction shown in the right figure (Y-axis facing the wall).
- 2 While pressing the [Y] key, turn on the power switch.
- 3 The flashing axis is the selected one.
Select the axis to check using the arrow keys (right and left) and press the [ENT] key to lock.

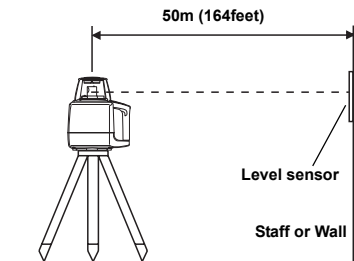
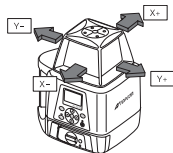

Turn on the power while pressing the [Y] key.



Select the axis using the arrow keys (right and left) and press the [ENT] key.



(Example: Y axis)

- 4 Select Y axis by pressing the right arrow key.
Press the [ENT] key to lock.
- 5 "POSITION 1" display will flash and the instrument will begin automatic alignment. After the automatic alignment is completed, the "POSITION 1" light will turn on, then, the rotary head rotates and emits laser beam. (Y-).
- 6 Turn on the power for the level sensor, and press the detective precision switch to select the high detection mode.
- 7 Check the position of the laser beam (Y-) on the wall.
Move the sensor up or down until the LCD indicator identifies the center of the laser beam.
- 8 After fixing the beam, press the [ENT] key.
The display will change to flashing "POSITION 2".

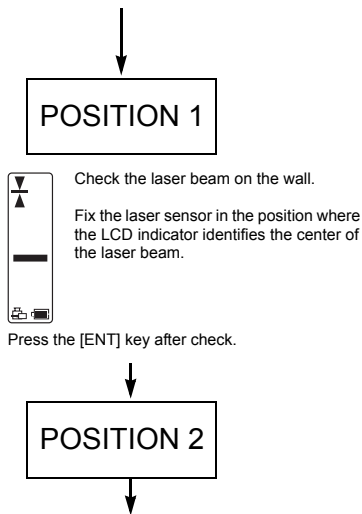

9 Loosen the tripod and rotate the instrument 180° and retighten to fix. The Y+ side of the instrument should be facing the wall. After the automatic alignment is completed, the display will change to [▲][▼], then, the rotary head rotates and emits laser beam.

10 Following step 7, mark the laser beam position for (Y+).

If the two lasers being marked are misaligned for less than 5mm, adjustment is not necessary. Turn off the power for the instrument. If adjustment is required, move on to (2) How to adjust.

(2) How to adjust

After completing the checking in step 10, go on to the adjustment specified below.

- 1 Using the arrow keys (up and down), adjust the (Y+) laser beam to the center of (Y+) and (Y-).
- 2 Press the [ENT] key when the laser beam is correctly positioned in the center.



Check the misalignment of laser beam of (Y+) and (Y-) on the wall.

If one of the 3 center indicators is lit, calibration is normal.

Misalignment of (Y-) and (Y+) laser beam within 5mm is considered normal.

Turn off the power to complete the checking.



When rotating the instrument 180°, ensure that the height of the instrument is aligned.



By using the up and down arrow keys of the remote controller, adjust the (Y+) laser beam to the center of the (Y-) and (Y+).

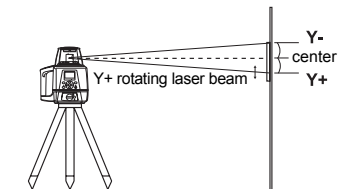

- 3 “CALCULATING” will flash indicating that the calibration value is being calculated by the instrument. Do not touch the instrument until “END” is displayed to signify operation completed. (If you touch the instrument, you will need to recalibrate.)
- 4 When “END” is displayed, press the [ENT] key. The screen will return to the axis selection screen. If you wish to continue with checking the X axis, go back to step 3 for calibration check.
- 5 When you have completed the adjustment, turn off the power. After adjustment is completed, go through the checking procedure to check if the adjustment was done accurately.

After positioning the laser beam, press the [ENT] key.

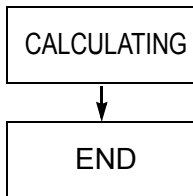

After calibration value is fixed, press the [ENT] key.

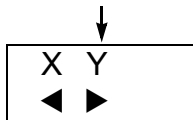

The screen goes back to the axis selection screen.



If the correction value calculated exceeds the allowable range, the RL-100 1S will display error code [CALIBRATION OVER ERR]. Check the procedure again and perform any inspections and adjustments.

Horizontal Rotation Cone Error

Perform the following check after completing “Horizontal Calibration” on the previous page.

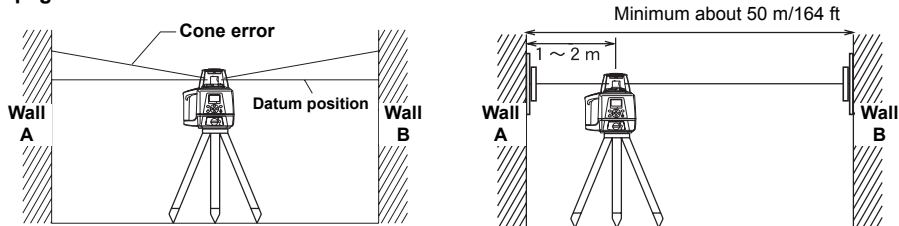

- 1 Set up the laser centered between two walls approximately 50 m (164 ft) apart. Orient the instrument so one axis, either X or Y, is facing the walls. Grade should be set to 0.00% in both axes.
- 2 Locate and mark the position of the rotating laser beam on both walls using the level sensor.
- 3 Turn off the instrument and move the instrument closer to wall A (1 m to 2 m / 3 ft to 6 ft). Do not change the axis orientation of the instrument. Turn the instrument on.
- 4 Again locate and mark the position of the rotating laser beam on both walls using the level sensor.
- 5 Measure the distance between the first and second marks on each wall.
- 6 If the difference between each set of marks is less than ± 5 mm ($\pm 7/32$ of an inch), no error exists.



If the difference between [wall A]-side and [wall B]-side exceeds ± 5 mm ($\pm 7/32$ of an inch), contact your dealer or Topcon.

Grade Setting Error

Perform the following check only after completing “Horizontal Calibration” and “Horizontal Rotation Cone Error”.

(1) Checking

1 Setup the Y+ side facing the staff as shown in the figure.

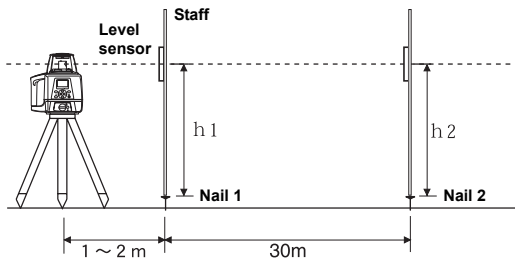

Securely position Nail 1 and Nail 2 exactly 30m apart.

2 Turn on power for the instrument and verify the staff height of Nail 1 and Nail 2 at grade setting of 0% with laser sensor and record.
At this time the staff height for Nail 1 and Nail 2 should recorded as h_1 and h_2 (mm). Check the laser sensor is set at high precision.

3 Set Y axis grade to 1.00%.

Align read the elevation of the laser beam in millimeters at Nail 1 and Nail 2.

Designate these elevations as “h3” at Nail 1, and “h4” at Nail 2.

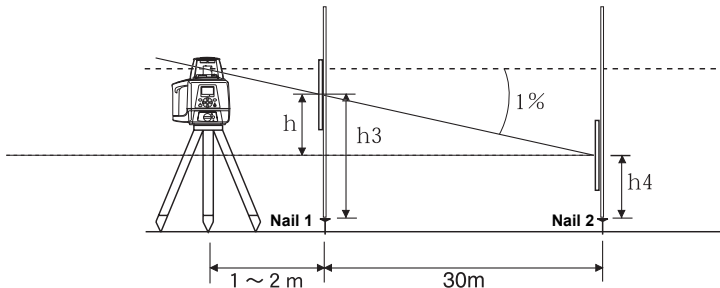

4 Using the elevation readings for h1, h2, h3 and h4, complete the equation below.

$$\gamma(\%) = \frac{h}{30000(\text{mm})} \times 100 = \frac{(h_2 - h_4) - (h_1 - h_3)}{30000} \times 100$$

If the calculated result is the range of 0.990% - 1.010%, the instrument is normal.

If the calculated result for either axis is out of the range, contact your dealer or Topcon.

Repeat the procedure aligning the “X” axis on the line created by Nail 1 and Nail 2.

Storage Precautions

- (1) Always clean the instrument after use.
 - 1) If the instrument got wet with rain, wipe it well before storing in the storage case.
 - 2) Wipe away stain or dirt with soft cloth after dusting.
- (2) Clean storage case using cloth moistened with neutral detergent or water. Do not use ether, benzene, thinner or other solvents.
- (3) Store with the batteries removed, when operation is halted for more than a month.

Rechargeable battery

Installing

- 1 Insert Ni-MH BT-67Q battery pack into the DB-67C battery holder.
- 2 Insert the battery pack into the instrument and turn the battery cover knob to “LOCK”.

Charging

- 1 Plug the AC/DC converter AD-11 into the DB-67C battery holder.
- 2 Plug the converter power cord into the appropriate AC outlet.
- 3 When charging is complete (after approximately seven hours), unplug the converter from the connector on the DB-67C battery holder.
- 4 Unplug the converter power cord from the AC receptacle.

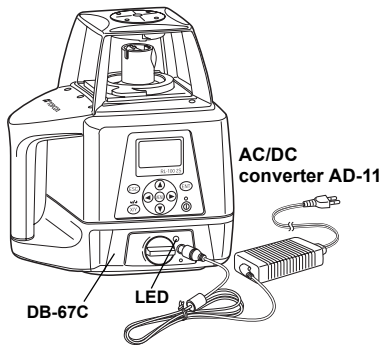

The LED of DB-67C will indicate charging status:

Red ON : Charging.

Green ON : Charging completed.

Green flashing : Ni-MH BT-67Q battery pack is not installed correctly.

Red flashing : Ni-MH BT-67Q battery pack protection feature is working automatically.
RL-100 1S can be used in this state.

The instrument has a protection feature which works when nickel hydride batteries are overcharged or when the batteries are under a high or low temperature ($+70^{\circ}\text{C}$ or higher, or 0°C or lower) state. In such a case, charging will stop automatically to protect nickel hydride batteries.



Recharging should be performed in a room temperature ranging from $+10^{\circ}\text{C}$ to $+40^{\circ}\text{C}$.
Always use the AC/DC converter provided with the product.



- 1) The Ni-MH BT-67Q rechargeable battery can be charged while using the laser.
- 2) The Ni-MH BT-67Q rechargeable battery can be charged when the battery holder is removed from the instrument. This allows the option of alternately using two battery packs to always maintain a fully charged pack.
- 3) The Ni-MH BT-67Q rechargeable battery can be removed from the DB-67C battery holder and four "D" cell alkaline batteries can be installed.
- 4) The DB-67 dry cell battery holder cannot be used to charge the BT-67Q Ni-MH battery pack. Use the DB-67C charging battery holder instead.

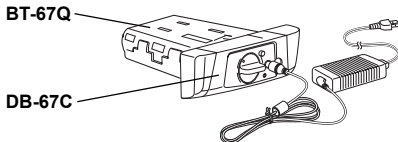



- 1) For longer battery life, conform to the suggested charging time to the extent possible.
- 2) The battery source will discharge when stored and should be checked before using with instrument.
- 3) Be sure to charge stored battery source every 3 or 6 months and store in a place at 30 °C or below.
If you allow the battery to become completely discharged, it will have an effect on future charging.

Standard/Optional Accessories

Level sensor holder model 6

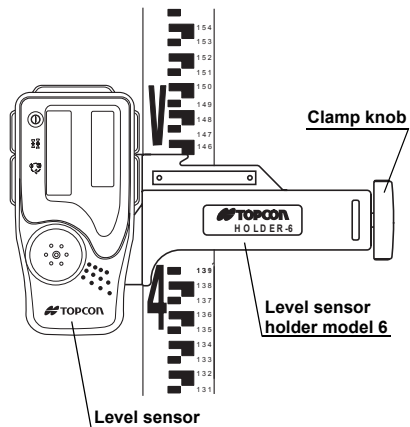

Level Sensor LS-80A / 80B

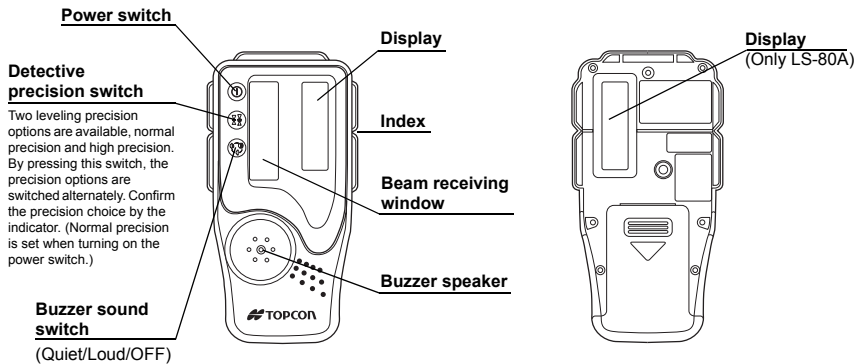

Auto-cut off function

The power will be turned off automatically if no laser beam is detected within approximately 30 minutes. (To turn the sensor on again, press the power switch.)

Display

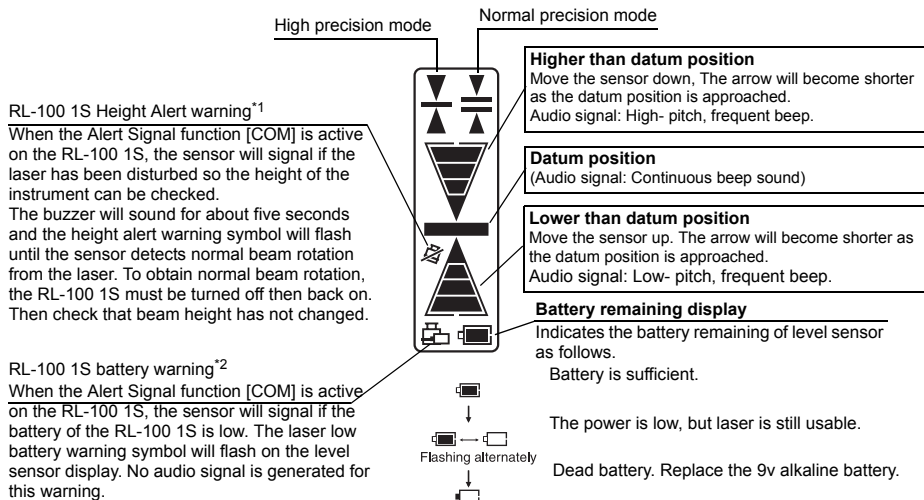

The warning signal *1 and *2 will function only if RL-100 1S Alert Signal function [COM] is active.

Alarm detection at the level sensor can be canceled by turning off the level sensor switch while pressing the buzzer sound switch. When the switch is turned back on again, alarm detection functions as usual.

Detective range

Mode Display	Mode	HIGH ▲▼	NORMAL ▲▼
		±1 mm/±.0032 ft (2 mm/.0064 ft width)	±2 mm/±.0064 ft (4 mm/.013 ft width)
		±5 mm/±.016 ft (10 mm/.032 ft width)	
		±10 mm/±.033 ft (20 mm/.066 ft width)	
		±15 mm/±.005 ft (30 mm/.010 ft width)	
		More than ±15 mm/.05 ft	
		Laser sensor has been moved above or below the laser beam. Move sensor in direction of arrow to receive laser.	

Replacing Battery

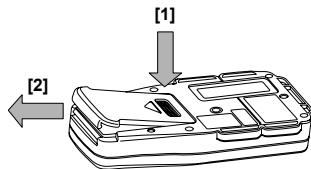

- 1 Keep pushing the battery lid in [1] direction, and then try to slide the lid in [2] direction to lift.
- 2 Remove the batteries from the battery box and insert new batteries (two AA dry batteries).
- 3 Press the lid down and click to close.

Scope Model 4

The optional scope replaces the sighting collimator (see page 18) on top of the instrument and provides greater accuracy in aligning the laser to the direction of grade. The scope can be swiveled and locked in place so its aimed toward any of the four beam axes. Using the scope, follow the steps on page 18 to align the instrument.

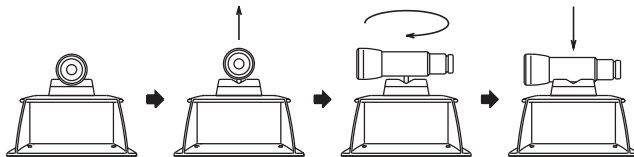

Specifications

RL-100 1S

Accuracy (reproducibility)	: ±10"
Auto-leveling range	: ±5°
Measuring range (Diameter)	: Approx. 2 – 800 m (6 - 2624.7 ft) with level sensor
Rotation speeds	: 300/600/900 rpm (Changeable)
Light source	: L.D (Visible laser)
Power supply	: 4D-CELL dry batteries (DC6V) Ni-MH battery pack BT-67Q (It can be charged while using it.)
Continuous operating time	Alkaline manganese dry battery : Approx. 85 hours Ni-MH battery pack BT-67Q : Approx. 80 hours
Tripod screw	: Flat and dome head type, 5"/8X11threads
Waterproof property/dust resistance	: JIS protection grade IP66
Water proof construction	: IP66 (Based on the standard IEC60529)
Operating temperature	: -20 °C to +50 °C (-4 °F to +122 °F)
Dimensions	: 174 (L) × 218 (W) × 253 (H) mm [6.9 (L) × 8.6 (W) × 10.0 (H) in]
Weight	: 3.4kg (7.5lbs) (Dry battery type: Including dry batteries)

LS-80A (Back side display area)**Detective range** : 50 mm (2.0 in)**Detective precision**High precision : ± 1 mm (± 0.04 in)Normal precision : ± 2 mm (± 0.08 in)**Detective beam indication**

: Liquid crystal and buzzer

Power source : **Two AA dry batteries****Power voltage** : **3VDC****Continuous operating time**

Alkaline manganese dry battery

: Approx. 120 hours

The time for auto-cut off

: Approx. 30 min.

Waterproof property/dust resistance

: JIS protection grade IP66

Operating temperature: -20 °C to $+50$ °C (-4 °F to $+122$ °F)**Dimensions** : 146 (l) \times 76 (w) \times 26 (h) mm: (5.7 (l) \times 3.0 (w) \times 1.0 (h) in)**Weight** : 0.19 kg (0.42 lbs)

: (including a dry battery)

LS-80B**Detective range** : 50 mm (2.0 in)**Detective precision**High precision : ± 1 mm (± 0.04 in)Normal precision : ± 2 mm (± 0.08 in)**Detective beam indication**

: Liquid crystal and buzzer

Power source : **Two AA dry batteries****Power voltage** : **3VDC****Continuous operating time**

Alkaline manganese dry battery

: Approx. 120 hours

The time for auto-cut off

: Approx. 30 min.







Waterproof property/dust resistance

: JIS protection grade IP66

Operating temperature: -20 °C to $+50$ °C (-4 °F to $+122$ °F)**Dimensions** : 146 (l) \times 76 (w) \times 26 (h) mm: (5.7 (l) \times 3.0 (w) \times 1.0 (h) in)**Weight** : 0.19 kg (0.42 lbs)

: (including a dry battery)

Error Display

Error Code	Description	Countermeasure
 RL-100 BATTERY LOW	Batteries of the instrument are dead.	Replace the batteries of the instrument.
	Safety lock system is activated.	Turn the power for the instrument off, and then turn it back on to activate automatic alignment function.
	The instrument is set up exceeding the alignment range.	Reposition the instrument to fit into the alignment range in the direction specified.
		
		
		
CALIBRATION OVER ERR	Checking mode identified as being exceeding calibration range.	Turn the power for the instrument; turn it back on and start over from the beginning.
E-05	The rotary head is not rotating	Turn the power for the instrument off, and then turn it back on.
E-60's	Encoder system error for the instrument	Turn the power for the instrument off, and then turn it back on.

Error Code	Description	Countermeasure
E-80's	Alignment is not completed	Turn the power for the instrument off, and then turn it back on.
E-99	Internal memory error for the instrument	Turn the power for the instrument off, and then turn it back on.
LCD backlight is flashing	Cannot be displayed	Turn the power for the instrument off, and then turn it back on.

If errors still persist after attempting to clear them, contact Topcon or your dealer.



FCC WARNING

This device complies with Part 15 of the FCC Rules. Operation is subject to the following two conditions: (1) this device may not cause harmful interference, and (2) this device must accept any interference received, including interference that may cause undesired operation.

CHANGES OR MODIFICATIONS NOT EXPRESSLY APPROVED BY THE MANUFACTURER FOR COMPLIANCE COULD VOID THE USER'S AUTHORITY TO OPERATE THE EQUIPMENT

CAUTION: This device and its antenna(s) must not be co-located or operating in conjunction with any other antenna or transmitter. End user cannot modify this transmitter device. Any unauthorized modification made on the device could avoid the user's authority to operate this device.

The following sentence has to be displayed on the outside of the device in which the transmitter module is installed:
"Contains FCC ID: PH3XE972

IC WARNING

The term “IC:” before the radio certification number only signifies that Industry Canada technical specifications were met.

“Operation is subject to the following two conditions:

- (1) this device may not cause interference, and
- (2) this device must accept any interference, including interference that may cause undesired operation of the device.”

“The installer of this radio equipment must ensure that the antenna is located or pointed such that it does not emit RF field in excess of Health Canada limits for the general population; consult Safety Code 6, obtainable from Health Canada’s website www.hc-sc.gc.ca/rpb”

The following sentence has to be displayed on the outside of the device in which the transmitter module is installed:

“Contains IC: 3070C-XE972

“This device has been designed to operate with the antennas listed below, and having a maximum gain of 0.61 dB. Antennas not included in this list or having a gain greater than 0.61 dB are strictly prohibited for use with this device. The required antenna impedance is 50 ohms.”

“To reduce potential radio interference to other users, the antenna type and its gain should be so chosen that the equivalent isotropically radiated power (e.i.r.p.) is not more than that permitted for successful communication.”

TOPCON POSITIONING SYSTEMS, INC.

7400 National Drive, Livermore, CA 94550, U.S.A.
Phone: 925-245-8300 Fax: 925-245-8599 www.topcon.com

TOPCON CALIFORNIA

3380 Industrial Blvd, Suite 105, West Sacramento, CA 95691, U.S.A.
Phone: 916-374-8575 Fax: 916-374-8329

TOPCON EUROPE POSITIONING B.V.

Essebaan 11, 2908 LJ Capelle a/d IJssel, The Netherlands.
Phone: 010-458-5077 Fax: 010-284-4941 www.topconeurope.com

IRELAND OFFICE

Unit 69 Western Parkway Business Center
Lower Ballymount Road, Dublin 12, Ireland
Phone: 01460-0021 Fax: 01460-0129

TOPCON DEUTSCHLAND G.m.b.H.

Giesslerallee 31, 47877 Willich, GERMANY
Phone: 02154-885-100 Fax: 02154-885-111 info@topcon.de
www.topcon.de

TOPCON S.A.R.L.

89, Rue de Paris, 92585 Clichy, Cedex, France.
Phone: 33-1-41069490 Fax: 33-1-47390251 topcon@topcon.fr

TOPCON SCANDINAVIA A. B.

Neongatan 2 S-43151 Mölndal, SWEDEN
Phone: 031-7109200 Fax: 031-7109249

TOPCON (GREAT BRITAIN)LTD.

Topcon House Kennet Side, Bone Lane, Newbury, Berkshire RG14 5PX U.K.
Phone: 44-1635-551120 Fax: 44-1635-551170
survey.sales@topcon.co.uk laser.sales@topcon.co.uk

TOPCON SOUTH ASIA PTE. LTD.

Blk 192 Pandan Loop, #07-01 Pantech Industrial Complex, Singapore 128381
Phone: 65-62780222 Fax: 65-62733540 www.topcon.com.sg

TOPCON INSTRUMENTS (THAILAND) CO., LTD.

77/162 Sinn Sathorn Tower, 37th Fl.,
Krungdhonburi Rd., Klongtongsai, Klongsarn, Bangkok 10600 Thailand.
Phone: 66-2-4401152~7 Fax: 66-2-4401158

TOPCON INSTRUMENTS (MALAYSIA) SDN. BHD.

Excella Business Park Block C, Ground & 1st Floor, Jalan Ampang Putra,
Taman Ampang Hilir, 55100 Kuala Lumpur, MALAYSIA
Phone: 60-3-42701192 Fax: 60-3-42704508

TOPCON KOREA CORPORATION

2F Yooseoung Bldg., 1595-3, Seocho-Dong, Seocho-gu, Seoul, 137-876, Korea.
Phone: 82-2-2055-0321 Fax: 82-2-2055-0319 www.topcon.co.kr

TOPCON CORPORATION BEIJING OFFICE

Block No.9, Kangding Street
Beijing Economic Technological Development Area, Beijing, China 100176
Phone: 86-10-6780-2799 Fax: 86-10-6780-2790

TOPCON CORPORATION DUBAI OFFICE

P. O Box293705, Office C-25(row C-2), Dubai Airport Free Zone, Dubai, UAE
Phone: 971-4-2995900 Fax: 971-4-2995901

TOPCON CORPORATION

75-1 Hasunuma-cho, Itabashi-ku, Tokyo 174-8580, Japan
www.topcon.co.jp